

A SYSTEM FOR MONITORING PRESSURES AND SPINAL CURVATURE IN SPINALLY INJURED PEOPLE IMMOBILISED ON A SPINAL RAFT

Ruairí de Fréin^{a,b)}, Eoin Flinn^{a,b)}, Annraoi de Paor^{a,b)}, Edward Burke^{a,b)}

^{a)} National University of Ireland, Dublin, Dept. of Electronic and Electrical Eng., Belfield, Dublin 4, Ireland.

^{b)} National Rehabilitation Hospital, Rochestown Ave., Dún Laoghaire, Co. Dublin, Ireland.

Summary We present a system designed to study the pressure at various 'hot spots' on the back of the body and the deformation of the spine experienced by a patient when strapped to a spinal board, and the potential alleviation of both by the addition of an inflatable "spinal raft" (or other similar device). In measuring pressure we devised a system of air-filled sacks interfaced with a PC. Each sack, placed under a particular key point on the body, is inflated until its faces just begin to separate and a switch thereby opens. The pressure reading is then captured and displayed by the computer. Seeking a non-invasive method of measuring the curvature of the vertebral column, we discovered that we could use a magnetometer to measure the vertical displacement of magnetically-tagged vertebrae from a fixed horizontal plane. The results of our study will be employed by an independent body to determine the merits or demerit of the spinal raft.

1. INTRODUCTION

When a person is suspected to have sustained a spinal injury, emergency paramedics typically strap the patient down tightly on a rigid board, known as a spinal board. The purpose of this board is to immobilise the spine in transit to a hospital, lest any movement should cause further damage to the spinal cord. In certain cases, particularly when a spinal injury occurs in a remote location, a patient may remain strapped to the board for several hours before being seen by an appropriate specialist. As well as being uncomfortable for the patient, prolonged immobilisation on a spinal board can have serious long-term medical consequences, including the formation of pressure sores and flattening of the spine.

Also known as decubitus ulcers, pressure sores occur when pressure is maintained over a number of hours on an area of skin, preventing adequate circulation of blood, leading to the death of skin cells in and around the point of contact [1,2]. Certain points on the back of a patient strapped to a spinal board are particularly at risk, including the back of the head, the shoulder blades and the buttocks. In cases where pressure sores do develop, the first signs are typically already visible when the patient is released from the spinal board. The skin at the points in question at first appears red and tender and within a few days rots away, leaving a large open wound. In addition to the discomfort associated with these lesions while they remain open, long-term problems persist even after healing. For example, the formation of a pressure sore on the back of the head may result in a permanent and unsightly bald patch.

For a patient strapped to a spinal board, the primary factors affecting the likelihood of occurrence of pressure sores are the magnitude of the pressure in each of the danger zones, the health of the patient (particularly skin condition and blood circulation) and the length of time spent on the board without repositioning [3,4].

The second problem associated with the use of spinal boards is flattening of the spine [5]. To minimise the chances of further damage occurring while the patient is on the spinal board, the spine should ideally be in as near as possible to neutral position. This is defined as the normal anatomical position of the head and torso that one assumes when standing looking straight ahead. Unfortunately, the spinal position of a patient strapped to a spinal board is often far from ideal [6]. In fact, even if the patient turns out not to have suffered a spinal injury, unnatural positioning of the spine on the spinal board can cause musculoskeletal damage [7].

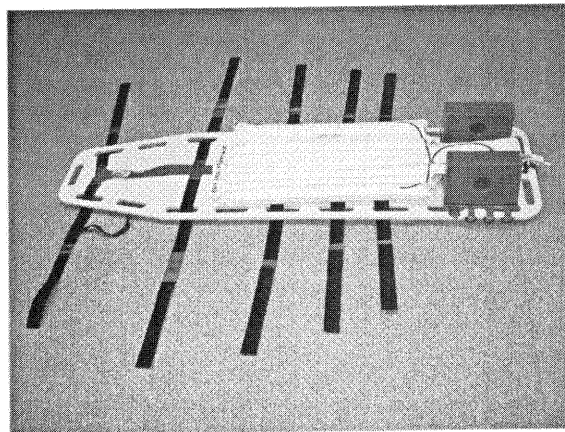

Fig. 1. The inflatable back raft on top of the rigid spinal board. Spread out to either side of the board are the velcro straps used to secure the patient.

It is hoped that the use of a back raft might alleviate the problems discussed above. This inflatable device is placed between the patient and the spinal board. The raft's cushioning effect is designed to redistribute the forces between the patient and spinal board, reducing the magnitude of the pressure at the points of likely pressure sore

formation and allowing the spine to assume a posture closer to neutral position than would otherwise be possible. The back raft is shown in Fig. 1.

In order to gauge the efficacy of the raft, a means of measuring the spinal curvature of a test subject strapped to the spinal board, as well as the pressure at certain points on the subject's back, both with and without the back raft, is required. In this paper, a system designed to fulfil this need is presented. It is proposed that this system be used in a study to assess the performance of the raft under real-world conditions, using real paramedics outside of the laboratory. To this end, the system has been designed with portability in mind. Both the custom-designed measurement apparatus used and original software are described.

2. PRESSURE MEASUREMENT

The system obtains a pressure reading at each of five critical areas on the back – the back of the head, both shoulder blades and both buttocks. The system is flexible and can be used to measure the pressure on other points, such as the sacrum, the heels and the back of the legs.

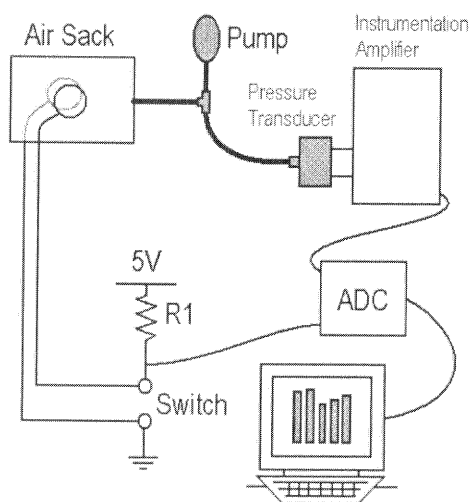

Fig. 2. Components of the pressure measurement system.

The pressure at each point is measured using an air-filled pressure measurement sack. This sack is formed from two small rectangles of thin rubber, each of which has a small metal contact at its centre, to which an insulated electrical lead is connected. One rectangle is placed on top of the other with the metal contacts touching. A rubber adhesive applied around the edges of the rectangles forms an airtight seal between the two, except at a single point where an air tube connects the inside and outside of the sack to allow inflation.

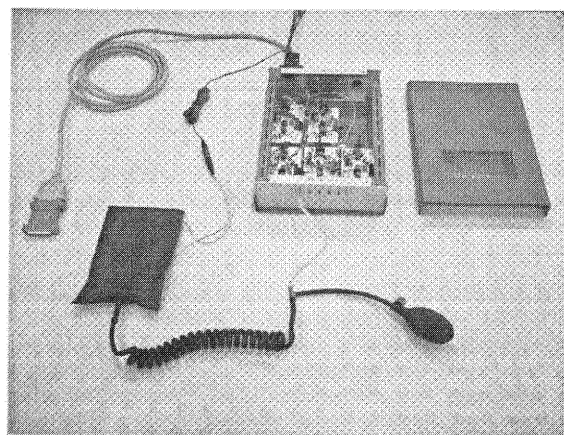

Fig. 3. The pressure measurement apparatus. Here, only one of the five pressure measurement sacks is connected to the unit housing the instrumentation amplifiers.

During pressure measurement, the sack is initially deflated. The metal contacts are touching as a result of which the two wires leading from the sack are short-circuited. The sack is placed under a point of interest on the subject's body and inflated using a hand pump until an open circuit between the two wires is sensed, indicating that the contacts have separated, and consequently that the air pressure within the sack is equal to that applied to its outer surface. Also connected to the hand pump is a SenSym SX Series gas pressure transducer that converts the air pressure within the sack into an analogue voltage. The computer is equipped with a PicoTech ADC11 analogue-to-digital converter (ADC), using which it monitors both the output voltage of the pressure transducer (via an instrumentation amplifier) and the state (either open circuit or short circuit) of each of the five sacks. The

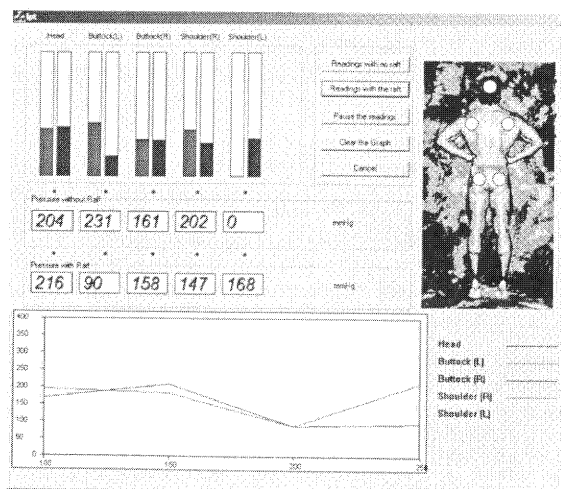

Fig. 4. A screenshot of the pressure measurement program's graphical user interface.

air pressure at the moment of separation of the contacts in a given sack is recorded by the computer as the pressure on the skin at the location of that sack on the subject's body. The pressure measurement system is illustrated in Fig. 2. A photograph of the apparatus is in Fig. 3.

Special software has been developed to record and display the pressure readings from each of the five sacks (see Fig. 4). During inflation, the pressure reading displayed for each sack varies in real-time. At the moment of contact separation for a given sack, the pressure reading for that sack freezes and an audible alarm is sounded to inform the user that he or she can move on to inflation of the next sack. The software also facilitates the recording of multiple sets of pressure measurements at different raft inflation pressures, in order to determine that which is optimal for the elimination of pressure peaks.

3. SPINAL CURVATURE MEASUREMENT

Estimation of spinal curvature of a subject strapped to the spinal board is achieved by placing permanent magnets on several of the subject's vertebrae and measuring the variations in the magnetic field along a horizontal path under the spinal board and directly beneath the spine. A Honeywell HMR2300 three-axis digital magnetometer is used to measure the magnetic field. The spinal board is placed on a wooden frame, mounted on which, 11cm beneath the board and running from its head to its foot, is a smooth plastic track, on which a small trolley travels up and down. A DC motor situated at the foot of the frame pulls the trolley, which carries the magnetometer, at a constant velocity by means of a thin nylon cord. The frame, track, motor and magnetometer are shown in Fig. 5.

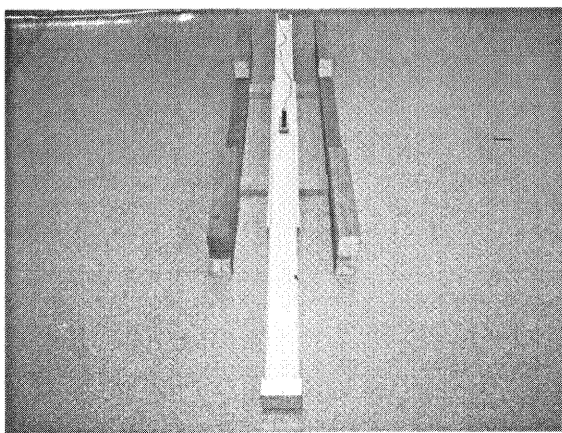

Fig. 5. The frame on which the spinal board rests during measurement of spinal curvature. The motor draws the magnetometer trolley along the plastic track by means of a thin nylon cord.

Each measurement of spinal curvature requires two passes of the magnetometer trolley along the track starting at the head of the board. The first pass is made prior to strapping the patient on the board for calibration purposes. At each point on the track, this scan gives a measurement of the ambient magnetic field due to the Earth's magnetic field, and distortions in that field due to ferrous or magnetic materials in the vicinity of the apparatus. The second pass is made once the test subject has been strapped to the board with the magnetic markers attached to his or her vertebrae. At any given point on the track, the field due to the magnetic vertebral marker alone can be obtained by subtracting from the measured value that which was recorded at the same point during the calibration scan. The position of each marker can be estimated from the location and magnitude of the corresponding peak in the measured magnetic field.

The readings from the magnetometer are relayed to the computer via the serial port at a rate of 30 samples per second. Each sample contains three orthogonal components. The data are recorded and displayed by specially developed software. Optionally, they may also be recorded to a data file in order to facilitate further analysis. The graphical user interface of this software is shown in Fig. 6.

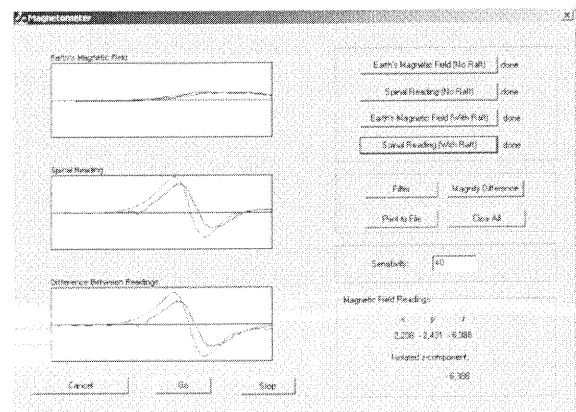

Fig. 6. Screenshot of the graphical user interface of the spinal curvature measurement

In order to determine the effect of the raft on spinal curvature, readings must be taken with and without the raft, preferably without changing any other test conditions. In each case, two scans are required, one to measure the ambient field and one with the subject strapped onto the board. Three graphs are displayed – one showing the result of the calibration scan, one showing the result of the scan with the markers and one showing the adjusted readings (i.e. with the ambient field subtracted from the second scan).

The magnetic markers used are cylindrical bar magnets, 26mm in length and 6mm in diameter. The north and south poles are at either end of the bar. These are attached flat on the back perpendicular to

the spine at the points of interest, which was considered satisfactorily comfortable by test subjects strapped down on the board. As the magnetometer passes beneath the magnet, the magnitude of the horizontal component of the magnetic field perpendicular to the direction of motion of the trolley is recorded. Each magnet produces a single peak in this signal.

In order to calibrate the system, a single magnetic marker was placed directly above the track on a platform of variable height. Beginning with the platform at a height corresponding to the upper surface of the spinal board, the magnetometer was passed repeatedly beneath the magnet, incrementing the height of the magnet above the track between each scan. This produced a series of curves like those shown in Fig. 7. This allowed peak field strength to be expressed as a function of the height of the marker above the track. This in turn, allows the height of the marker to be inferred from the peak field strength, during the experiment.

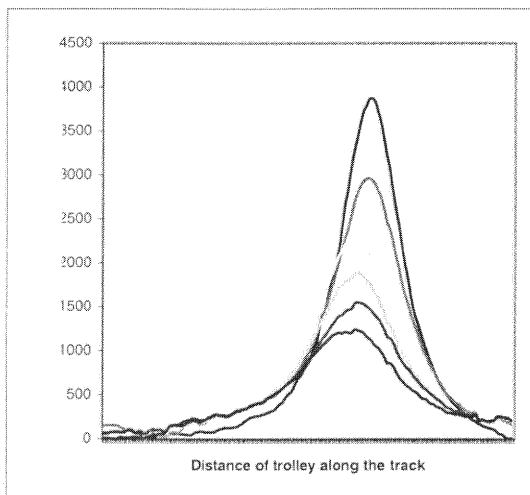

Fig. 7. Calibration curves for the spinal curvature measurement system. In this graph, each curve corresponds to a scan carried out with the magnetic marker placed at a different height.

5. CONCLUSION

The apparatus and procedure described here for assessing the effectiveness of an inflatable back raft in reducing the problems associated with the use of rigid spinal boards has been shown to be adequate both in the measurement of pressure and of spinal position.

The technique used to measure pressure on the skin's surface at various points has proven to be effective, convenient and flexible despite being a very low-cost solution. Furthermore, the same apparatus has the potential to be used in a wide variety of related applications, including assessment

of seating, beds, etc for paralysed or immobilized people.

Although the principle of using magnetic markers to measure spinal curvature has been shown to be practical, certain problems associated with the current system are outstanding. The number of magnetic markers that can be used concurrently is limited by the problem of mutual interference between adjacent magnetic markers. This means that in order to measure the position of more than a small number of points on the spine, the measurement procedure must be carried out more than once, using only a small number of markers each time and moving the markers manually between readings. The extra time associated with this retesting is undesirable in the context of a study using large numbers of test subjects. However, it is hoped that the problem of mutual interference can be overcome by using electromagnetic markers that could be activated one at a time, under computer control, during the scan. Furthermore, this would eliminate the need for a separate scan to measure the ambient field.

REFERENCES

- [1] K. Curry, L. Casady, "The relationship between extended periods of immobility and decubitus ulcer formation in the acutely spinal cord-injured individual," *J. Neurosci. Nurs.* 24, pp. 185-189, 1992.
- [2] P.W. Main, M.E. Lovell, "A review of seven support surfaces with emphasis on their protection of the spinally injured," *J. Accid. Emerg. Med.*, Vol. 13, Issue 1, pp. 34-37, 1996.
- [3] R. Silbergleit, D.K. Dedrick, J. Pape, R.E. Burney, "Forces acting during air and ground transport on patients stabilized by standard immobilization techniques," *Ann. Emerg. Med.* 20(8), pp. 875-877, Aug. 1991.
- [4] E.B. Lerner, R. Moscati, "Duration of patient immobilization in the emergency department," *Am. J. Emerg. Med.* 18(1), pp. 28-30, 2000.
- [5] R. Walton, J.F. DeSalvo, A.A. Ernst, A. Shahane, "Padded vs unpadded spine board for cervical spine immobilization," *Acad. Emerg. Med.* 2(8), pp. 725-728, Aug. 1995.
- [6] D.L. Schriger, B. Larmon, T. LeGassick, T. Blinman, "Spinal immobilization on a flat backboard: does it result in neutral position of the cervical spine?" *Ann. Emerg. Med.* 20(8), pp. 878-881, Aug. 1991.
- [7] D. Chan, R. Goldberg, A. Tascone, S. Harmon, L. Chan, "The effect of spinal immobilization on healthy volunteers," *Ann. Emerg. Med.* 23(1), pp. 48-51, 1994.